

# User Guide

## Webasto Go Mobile Charger

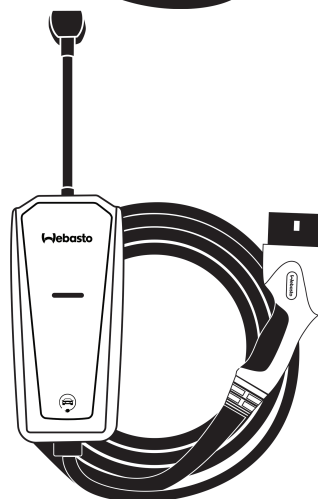

English

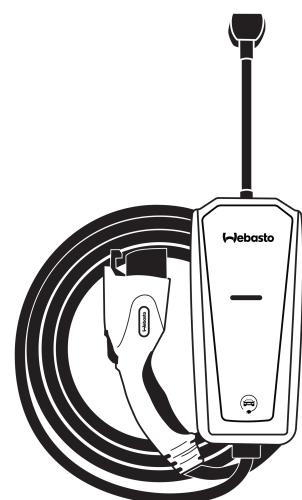
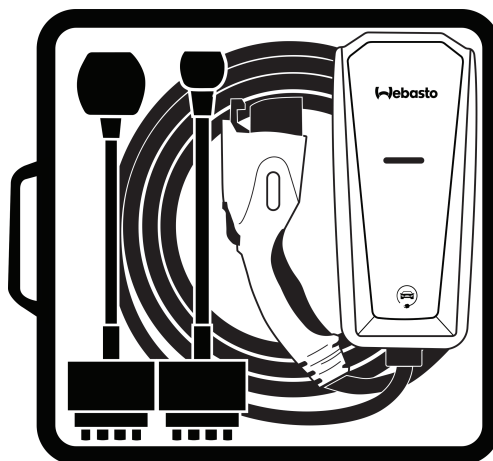

## Table of Contents

<b>1</b>	<b>General information.....</b>	<b>3</b>
1.1	Purpose of this document.....	3
1.2	Using this document.....	3
1.3	Intended Use .....	3
1.4	Use of symbols and highlighting .....	3
1.5	Warranty and liability.....	3
<b>2</b>	<b>Important safety information .....</b>	<b>3</b>
2.1	General information .....	3
2.2	General safety information .....	3
2.3	High voltage warning .....	4
2.4	Safety information .....	4
<b>3</b>	<b>Technical data .....</b>	<b>4</b>
3.1	Labels US.....	4
3.2	Labels EU and UK .....	5
3.3	Unit description .....	5
3.4	Safety features.....	5
<b>4</b>	<b>Installation.....</b>	<b>6</b>
<b>5</b>	<b>Using your Webasto Go Mobile Charger</b>	<b>6</b>
5.1	Indicator light .....	6
5.2	Charging Your Vehicle .....	6
5.3	Auto restart .....	7
<b>6</b>	<b>Care instructions.....</b>	<b>7</b>
<b>7</b>	<b>Moving and Storage instructions.....</b>	<b>7</b>
<b>8</b>	<b>Troubleshooting .....</b>	<b>8</b>
8.1	Troubleshooting .....	9
<b>9</b>	<b>Disposal .....</b>	<b>11</b>
<b>10</b>	<b>Declaration of conformity.....</b>	<b>11</b>
10.1	FCC information .....	11

# 1 General information

## 1.1 Purpose of this document

This manual contains important instructions for the Webasto Go Mobile Charger that should be followed during installation, operation and maintenance of the product.



### NOTE

In addition to this document, follow and comply with local regulations and standards relating to operation, installation and environmental protection.

## 1.2 Using this document

- ▶ Read this document carefully before you install or use the Webasto Go Mobile Charger.
- ▶ Keep these instructions for future reference.

## 1.3 Intended Use

The Webasto Go Mobile Charger is designed for charging electric vehicles in accordance with IEC 62752, charge mode2. In this charge mode, the mobile charger ensures: The voltage is not applied before the vehicle has been connected correctly.

The maximum power is calibrated. See also: <https://www.iso.org/obp/ui/#iso:std:iec:62752:ed-1:v1:en:fig:E.1>.

## 1.4 Use of symbols and highlighting



### DANGER

This signal word denotes a hazard with a **high** degree of risk which, if not avoided, may lead to death or serious injury.



### WARNING

This signal word denotes a hazard with a moderate degree of risk which, if not avoided, may lead to minor or moderate injury.



### CAUTION

This signal word denotes a hazard with a **low** degree of risk which, if not avoided, may lead to minor or moderate injury.



### NOTE

This symbol denotes a special technical feature, or (if not observed) potential damage to the product.

## 1.5 Warranty and liability

Webasto shall not assume liability for defects or damage that are the result of the installation and operating instructions being disregarded. This liability exclusion particularly applies for:

- Improper use.
- Repairs carried out by an electrician not contracted by Webasto.
- Use of non-original spare parts.
- Unauthorised conversion of the unit without permission from Webasto.
- Installation and commissioning by unqualified staff (not an electrician).
- Improper disposal after decommissioning.



### NOTE

In case of any claims, defects or damage to your project, you must contact your direct contractual partner, installation partner or dealer.



### WARNING

Installation and connection of the charging station must only be carried out by a qualified electrician.



The symbol of a bin with a line through it means that the instructions in the chapter on Disposal must be followed.



The Webasto Go Mobile Charger should not be operated at altitudes of more than 13,123 ft. (4000 m) above sea level.

# 2 Important safety information

Read and comply with warnings in this User Guide.

## 2.1 General information

The Webasto Go Mobile Charger is an easy-to-use, compact portable power supply for electric vehicle. The charger supplies and manages AC power to your electric vehicle and is compatible with a variety of battery electric vehicles and plug-in hybrids.

The charger operates from a 120 – 240 VAC (Single Phase) 50 – 60 Hz power source.

Key features:

- Compact portable design
- Overheating protection
- Quick-read status indicators
- Multiple adapters available for versatile usage in a variety of locations
- Overvoltage protection

## 2.2 General safety information



### WARNING

This product must be grounded. If it should malfunction or break down, grounding provides a path of least resistance for electric current to reduce the risk of electric shock. This product comes with two adapters, each adapter has a grounding adapter and a grounding plug. The adapter must be inserted into an appropriate wall socket that is properly installed and grounded in accordance with all applicable local and national standards and regulations.



### WARNING

#### Risk of electric shock

Improper connection of the electrical wall socket grounding conductor might result in a risk of electric shock. Check with a qualified electrician if you are uncertain whether or not the electrical wall socket is properly grounded. Do not modify the plug provided with the product if it does not fit in the wall socket. Have a proper wall socket installed by a qualified electrician.



### WARNING

Electrical wall sockets for use with your charger must be installed by a licensed, qualified electrician. To avoid serious injury or death, installation must comply with all applicable local and national standards and regulations.



### WARNING

Do NOT DROP the control box or coupler.  
Do NOT use if stored outside temperature range specified.



**WARNING**

If the cable becomes separated from the control box or the charger coupler, **DO NOT ATTEMPT TO REPAIR THE CABLE YOURSELF**. Contact your local Webasto dealer for assistance. You can find your nearest dealer at: <https://dealerlocator.webasto.com/en-int>.



**WARNING**

- When using your Webasto Go Mobile Charger, you must follow the following basic precautions amongst others:
- ▶ See the warnings on charger cord label. Read the warnings before operating the product for the first time. Read all instructions in this guide before using this product.
  - ▶ Never use the charger with an extension cord.
  - ▶ Do not plug into worn or severely degraded plugs.
  - ▶ Shock hazard – be sure the plug is fully inserted into the wall socket so that there are no exposed blade surfaces.
  - ▶ Children should be supervised when in the vicinity of the charger while plugged in.
  - ▶ Do not insert fingers into the electric charge coupler.
  - ▶ Do not use in a commercial garage classified for internal combustion engine vehicles due to gasses of flammable liquids (fuels) being present.



**CAUTION**

Do not connect or disconnect any pluggable component (adapter) of the Webasto Go Mobile Charger while the IC-CPD (control box) is in use or charging (adapter plug connected in a wall socket or the vehicle coupler connector is engaged in a vehicle inlet).



**CAUTION**

Do not operate the Webasto Go Mobile Charger in temperature outside its operation range of -22 °F to +122 °F (-30 °C to +50 °C).



**CAUTION**

Store the Webasto Go Mobile Charger in a clean dry place in temperature between of -22 °F to +185 °F (-30 °C to +85 °C).



**CAUTION**

To reduce the risk of fire, connect only to a circuit provided with 40 amperes maximum branch circuit overcurrent protection in accordance with the National Electrical Code.

**2.3 High voltage warning**



**DANGER**

High voltage is present in your electric meter housing and power distribution service panel. Contact with high voltage can cause death or serious personal injury.



**DANGER**

**Risk of electric shock**

Parts inside this product are a risk of shock to persons.



**WARNING**

**DO NOT** operate your charger with a damaged adapter, cable, charger coupler, or control box. Visually inspect the cable, charge coupler, and charger module for damage before each use. Do not operate if any visual damage is apparent anywhere and contact your contractual partner.



**WARNING**

**ALWAYS** position the charger cable so that it will not be driven over, stepped on, tripped over, or otherwise damaged or stressed. To prevent personal injury and damage to the charger, **ALWAYS** stow the charger on hanger or in stowage bag after use.



**WARNING**

Use the charger only to supply power to electric vehicles equipped with an SAE J1772 or IEC 62196-2 compliant vehicle receptacle. For more information, refer to the vehicle owner's manual.



**NOTE**

Disconnect the charger from the wall socket before cleaning it. To clean the charger, wipe it with a clean cloth dampened with water or a mild detergent solution suitable for use on automobile paint. Do not use chemicals or solvents. Do not submerge the charger in any type of fluid.

**2.4 Safety information**



**WARNING**

This product contains a chemical known to the State of California to cause cancer or birth defects or other reproductive harm.

**3 Technical data**

**3.1 Labels US**

**CCID Caution US Webasto**

<p><b>Input/Output Rating</b> Consumption/ Rendement Calificación eléctrica de entrada/ Calificación eléctrica de salida.</p>	<p>120-240V AC ~ 50-60 Hz, MAX 32A. See Adapter Plug. Vous voyez la fiche de l'adaptateur. / Ve el enchufe del adaptador.</p>
<p><b>Temperature Rating /</b> Cote de température / Calificación de temperatura</p>	<p>-30C to 50C -22 F to 122 F</p>
<p><b>Type / La Catégorie / Tipo</b></p>	<p>6, IP67</p>

2 Read owner's manual before operating. / Vous lisez le manuel de l'utilisateur avant d'utiliser. / Lee el manual del propietario antes de operar.

3 **WARNING / AVERTISSEMENT / ADVERTENCIA**

- This device is intended only for charging vehicles not requiring ventilation during charging. / Cet appareil est uniquement destiné à charger des véhicules ne nécessitant pas de ventilation pendant la charge. / Este dispositivo está diseñado solo para cargar vehículos que no requieren ventilación durante la carga.
- This device has an automatic reset feature. / Cet appareil est équipé d'un dispositif de réinitialisation automatique. / Este dispositivo tiene una función automática de reprogramación.
- Do not use this with an extension cord. / Ne pas utiliser cet appareil avec une rallonge électrique. / No lo use con un cordón de extensión.

**CAUTION / ATTENTION / PRECAUCIÓN**

- Connect only to properly grounded outlets. / Brancher uniquement sur des prises de courant dûment mises à la masse. / Conectar solamente a tomacorrientes con la descarga apropiada a tierra.
- Do not use this product if there is any damage to the unit. / N'utilisez pas ce produit s'il y a des dommages à l'unité. / No use este producto si hay algún daño en la unidad.
- Do not remove cover or attempt to open the enclosure. No user serviceable parts inside. Refer servicing to qualified service personnel. / Ne pas retirer le couvercle ou essayer d'ouvrir le boîtier. Aucune pièce ne peut être changée par l'utilisateur. Faire appel à une personne qualifiée pour tout service de dépannage. / No saque la funda ni intente abrir el armazón. No hay piezas interiores que pueda reparar el usuario. Derive el servicio a personal de servicio calificado.

Fig. 1 Label CCID Caution US Webasto

1 Technical specifications	2 Information
3 Warnings	

Product ID SAE

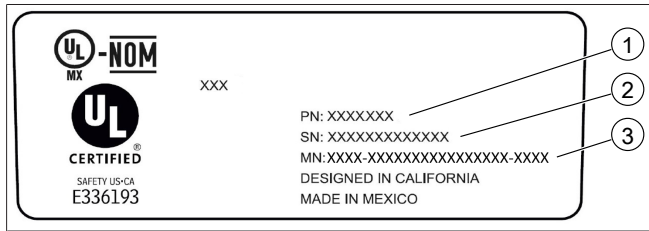

Fig. 2 Label Product ID SAE

1	Part number	2	Serial number
3	Manufacturing number		

3.2 Labels EU and UK

CCID Caution EU and UK Webasto

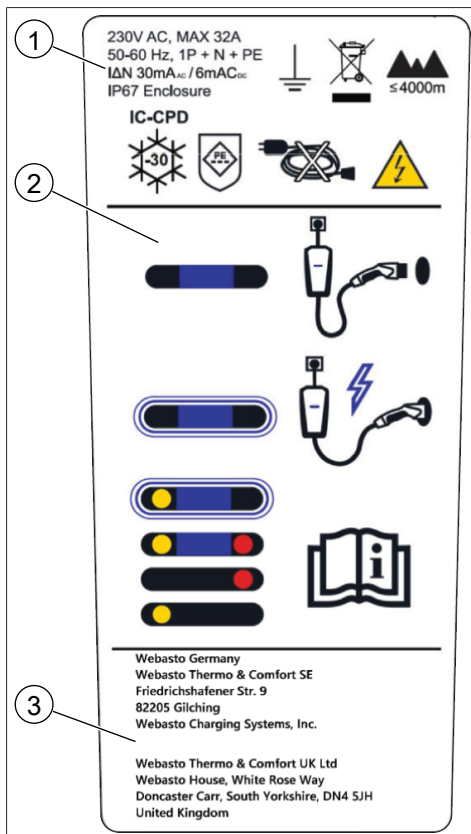

Fig. 3 Label CCID Caution EU and UK Webasto

1	Technical specifications	2	Light indicator
3	Address information		

Product ID IEC



Fig. 4 Label Product ID IEC

1	Part number	2	Serial number
3	Manufacturing number		

3.3 Unit description

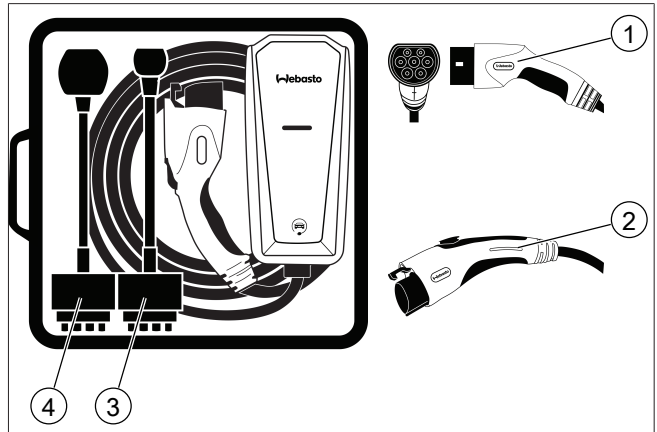

Fig. 5 Webasto Go Mobile Charger

1	Type 1 IEC Coupler	2	Type 2 SAE Coupler
3	Low Power Adapter	4	High Power Adapter

Charger model	SAE (North America)	IEC (Europe)
Voltage (V AC)	120 - 240 V AC	230 V AC
Maximum current (A)	32 A max continuous	32 A max continuous
Frequency (Hz)	60 Hz	50 Hz
Power draw at idle (W)	< 2 W	< 2 W
During charging (W)	< 4 W	< 4 W
Cable length (ft / m)	Approx. 20 ft / 6.1 m	Approx. 18.4 ft / 5.6 m
Weight: (lbs / kg)	8.6 lbs / 3.9 kg	9.2 lbs / 4.2 kg
Temperature – operating: (C / F)	-22 °F to +122 °F -30 °C to +50 °C	-22 °F to +122 °F -30 °C to +50 °C
Temperature – storage: (C / F)	-22 °F to +185 °F -30 °C to +85 °C	-22 °F to +185 °F -30 °C to +85 °C
CCID environmental rating: (NEMA/IP)	NEMA 6 (watertight)	IP67 (watertight)
Ventilation	Not required	Not required
Specifications are subject to change without notice.		
Usable for Indoor and Outdoor		

The Webasto Go Mobile Charger comes standard with two adapters:

- One high power adapter
- One low power adapter

Please refer to your vehicle owner’s manual for details on included and available adapters and accessories.

3.4 Safety features

The Webasto Go Mobile Charger is designed with your safety as the highest priority and includes the following safety features to protect against the risk of electric shock:

- **Service Ground Check:** The charger constantly checks for the presence of a service ground connection. If the service ground ever fails, the charger RED Indicator turns ON and shuts down power to the vehicle.
- **Thermal Event Sensor:** Charger module senses out-of-ordinary thermal events and will decrease charging current or shut the unit down if required.
- **GFCI Protection:** The Webasto Go Mobile Charger is equipped with a ground fault circuit interruption (GFCI) reaction system to protect against electric shock. If the char-

ger module detects an output ground fault, it will shut down power to the output cable and illuminate the RED indicator.

- **Insulation:** The charger module, adapter, cable assembly, and charge coupler are completely insulated (no exposed live parts) to protect against electric shock.
- **Unintentional Disconnection:** The charge coupler is designed to minimize unintentional disconnection. A pilot signal wire in the cable and charge coupler eliminates the possibility of electric shock when not connected to a vehicle or if an unintended disconnect occurs during a charge. Disconnection during charging is safe.

## 4 Installation

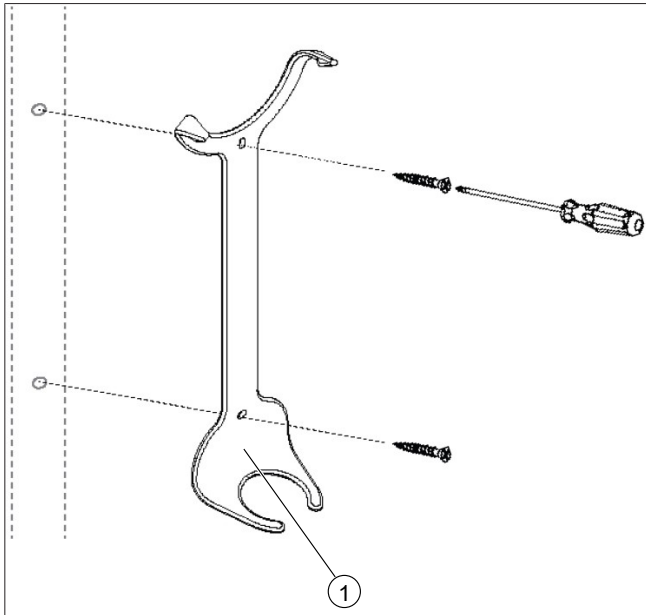

Fig. 6 Wall hanger

1	Wall hanger
---	-------------

1. Choose a location to install the wall hanger.

**NOTE**  
The Webasto Go Mobile Charger can be used indoors and outdoors.

**NOTE**  
The hanger should be located in practical proximity to both the utility receptacle or plug, and the location of your vehicle's charge receptacle, preferably mounted to a wall stud.  
Drywall and masonry wall installations require the use of appropriate fasteners.

2. Measure up approximately 8 inches / 20 cm from the desired receptacle and mark the location.

**NOTE**  
Before drilling any holes, verify that the control box will sit in hanger after it is plugged in.

3. Drill out the preferred mounting holes through the back of the wall hanger using a 7/32 inch / 5.6 mm drill bit.
4. Using a screwdriver, tighten the screws for the wall hanger.

## 5 Using your Webasto Go Mobile Charger

### 5.1 Indicator light

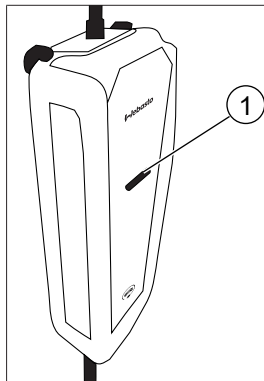

Fig. 7 Webasto Go Mobile Charger

1	Indicator light
---	-----------------

The indicator light on your charger is the first thing you will notice when you are about to plug or unplug your vehicle. Before getting started, here is a simple explanation of the indicators.

#### AMBER Indicator

The AMBER Indicator illuminates to indicate the charger is re-booting after an error. Refer to the chapter 8.1, "Troubleshooting" on page 9 for more information.

#### BLUE Indicator

When plugged into the wall socket, the BLUE Indicator illuminates to indicate the charger is ready to use. During charging, the BLUE Indicator will pulse on and off every two seconds. Refer to the chapter 8.1, "Troubleshooting" on page 9 for more information.

#### RED Indicator

The RED Indicator illuminates when the charger detects an error. If the RED Indicator illuminates, the charger will not deliver power to the vehicle. The error must be corrected before a charging cycle can begin or continue. Refer to the chapter 8.1, "Troubleshooting" on page 9 for more information.

### 5.2 Charging Your Vehicle

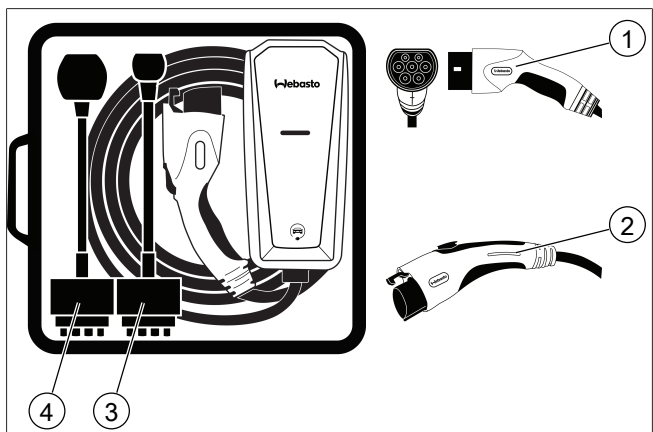

Fig. 8 Webasto Go Mobile Charger

1	Type 1 IEC Coupler	2	Type 2 SAE Coupler
3	Low Power Adapter	4	High Power Adapter

**NOTE**  
If Wall bracket is not used for mounting the cordset, plug cordset to wall socket closer to ground.

**NOTE**

Note the following safety features chapter 3.4, "Safety features" on page 5.

1. Make sure the vehicle is in park (P).
2. Insert the adapter firmly into the control box.
3. Firmly insert the other end of the adapter into the appropriate wall socket.

**NOTE**

You will hear an audible "click" when the adapter is correctly inserted into the control box – make sure the adapter is fully inserted and flush with the control box before inserting the other end into the wall socket. Otherwise, it will trigger a fault or cause a longer charge session.

4. When the wall plug is inserted:
  - The AMBER, BLUE and RED indicators will blink once. Then the BLUE Indicator turns ON, followed by a blink of the RED indicator. Lastly, the BLUE indicator turns OFF, then ON again. This cycle will happen twice if a different adapter is used from previous charge.
5. Plug the coupler into your vehicle's charging inlet:
  - **Type 1 Coupler:** When coupler is fully inserted there will be an audible clicking sound.
  - **Type 2 Coupler:** The coupler will lock in place once it is fully inserted.
6. When charging begins:
  - The BLUE Indicator will pulse on and off approximately every two seconds.
7. When charging ends:
  - The BLUE Indicator will illuminate solid blue.
8. To disconnect the coupler from the vehicle charge port:
  - **Type 1 Coupler:** Press the release button on the coupler, then pull the coupler away from the vehicle.
  - **Type 2 Coupler:** Press the vehicle's Cord Unlock Button, then pull the coupler way from the vehicle.

**NOTE**

When plugging the charger into an unfamiliar wall socket, it is good practice to take few minutes to observe the charging process and confirm it is supplying the expected AC charging power before leaving the charger unattended.

The RED Indicator will illuminate if it is not charging. The unit will turn OFF if a breaker or infrastructure GFI is tripped.

**NOTE**

For more information about how to charge your vehicle, including charge settings and scheduling, refer to the vehicle owner's manual.

**NOTE**

The IC-CPD adaptor shall except if the adaptor is part of the IC-CPD and pluggable IC-CPD.

The components of a pluggable IC-CPD must be disconnected while the IC-CPD is in use (infrastructure or the vehicle connector is engaged in a vehicle inlet).

The IC-CPDs shall be used in accordance with their instructions.

## 5.3 Auto restart

The Auto-Restart feature helps to ensure that your vehicle will be charged and ready for use when needed. A charge may be interrupted if an error is detected. Charging will resume once the error is no longer detected. The RED Indicator illuminates during an error condition.

The exception to immediate Auto-Restart is when the interruption is due to a ground fault circuit interruption (GFCI). The charger will attempt to restart 15 minutes after this happens. After a fourth attempt to restart, the charger will shut down and the RED Indicator will stay ON.

If the fault persists, do not continue to try to charge your vehicle. Contact your Webasto dealer.

## 6 Care instructions

Do not use hard cleaners or solvents as this may damage your Webasto Go Mobile Charger. Do not kink or place undue stress on the charger cables. If the charger overheats, bring out of direct sunlight.

## 7 Moving and Storage instructions

If improper moving or storage of the device is able to result in damage to the product that could result in a risk of fire or electric shock during subsequent use, the instructions shall describe the proper moving and storage procedure, and shall be preceded by the heading chapter 7, "Moving and Storage instructions" on page 7 or the equivalent.

Instructions for moving the device shall state that the device is not to be lifted or carried by either the flexible cord or the EV cable, if provided. The appropriate means for carrying and moving the device shall be described.

Instructions for the proper storage of the device, including location, temperature limits, and the like, shall be provided in the Moving, Transporting and Storage Instructions.

## 8 Troubleshooting

Please refer to this Troubleshooting Guide for possible solutions to common errors or difficulties with charging your vehicle using your mobile charger.

 **NOTE**

**Troubleshooting**

If you experience any troubles in the initial moment of installation and operating the Webasto Go Mobile Charger, please contact your contractual partner for support.

 **NOTE**

Do not attempt to repair or service the charger yourself. There are no user serviceable parts inside this product.

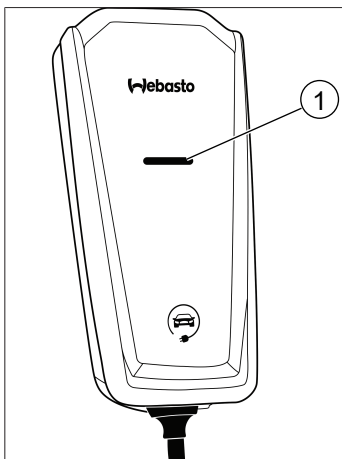

Fig. 9 Indicator light

1 Indicator light

A red indicator may be triggered by sources such as the charger, the utility service, and the vehicle. See chapter , "Troubleshooting" on page 9. The red indicator turns on when the charger detects an error, whether it is connected to your vehicle or not. If the red indicator is on, then the charger will not deliver power to the vehicle. Correct the error for charging to begin or resume.



## 8.1 Troubleshooting

CHARGER MODE	AMBER INDICATOR	BLUE INDICATOR	RED INDICATOR	MODE EXPLANATION	TROUBLESHOOTING ACTION
UNPOWERED	OFF	OFF	OFF	THE MOBILE CHARGER IS NOT POWERED. IF LED INDICATORS ARE OFF AFTER PLUGGING THE ADAPTER INTO THE WALL SOCKET, THERE MAY BE NO POWER FROM THE WALL SOCKET.	MAKE SURE THE WALL SOCKET IS OPERATIONAL AND THE CIRCUIT BREAKER IS IN THE "ON" POSITION. TRY USING ANOTHER WALL SOCKET. ENSURE ADAPTER IS FULLY INSERTED. ENSURE PLUG IS NOT SEVERELY DEGRADED. IF THE ERROR PERSISTS, CONTACT YOUR CONTRACTUAL PARTNER FOR SUPPORT.
CHARGING	OFF	PULSING	OFF	THE MOBILE CHARGER IS SUCCESSFULLY CHARGING.	NO ACTION REQUIRED.
STANDBY	OFF	ON	OFF	THE MOBILE CHARGER IS POWERED AND READY TO CHARGE. THE MOBILE CHARGER IS NOT CHARGING THE VEHICLE.	IF YOU EXPECT THE MOBILE CHARGER TO BE CHARGING THE VEHICLE, ENSURE THE VEHICLE COUPLER IS PROPERLY INSERTED INTO THE VEHICLE. CHECK AND ADJUST YOUR CHARGING TIME PREFERENCES IN SYNC. IF THE VEHICLE IS STILL NOT CHARGING, CONTACT CONTRACTUAL PARTNER FOR SUPPORT.
REBOOTING	ON	ON	ON	THE MOBILE CHARGER IS AUTOMATICALLY RECOVERING AFTER ENCOUNTERING AN ERROR.	WAIT FOR THE MOBILE CHARGER TO RETURN TO STANDBY. IF THE MOBILE CHARGER CYCLES FOR MORE THAN 2-3 MINUTES, UNPLUG THE VEHICLE COUPLER. UNPLUG AND REPLUG IN THE ADAPTER. IF THE ISSUE PERSISTS, CONTACT CONTRACTUAL PARTNER FOR SUPPORT.
CHARGING REDUCED	ON	PULSING	OFF	THE MOBILE CHARGER IS CHARGING AT A REDUCED RATE DUE TO OVERHEATING.	ENSURE THE ADAPTER AND CONTROL BOX ARE PROPERLY CONNECTED. DISCONNECT, THEN RECONNECT THE ADAPTER. IF THE MOBILE CHARGER IS WARM OR IN A HOT ENVIRONMENT, TRY CHARGING IN A COOLER AREA. TRY A DIFFERENT WALL SOCKET. TRY A DIFFERENT ADAPTER IF YOU HAVE ONE AVAILABLE. IF THE ERROR PERSISTS, CONTACT CONTRACTUAL PARTNER FOR SUPPORT.
CHARGING REDUCED (AC PLUG OR WALL SOCKET)	1 FLASH	PULSING	OFF	THE MOBILE CHARGER IS CHARGING AT A REDUCED RATE DUE TO OVERHEATING OF THE ADAPTER OR THE WALL SOCKET.	ENSURE THE ADAPTER AND CONTROL BOX ARE PROPERLY CONNECTED. DISCONNECT, THEN RECONNECT THE ADAPTER. IF THE MOBILE CHARGER IS WARM OR IN A HOT ENVIRONMENT, TRY CHARGING IN A COOLER AREA. TRY A DIFFERENT WALL SOCKET. TRY A DIFFERENT ADAPTER IF YOU HAVE ONE AVAILABLE. IF THE ERROR PERSISTS, CONTACT CONTRACTUAL PARTNER FOR SUPPORT.

CHARGER MODE	AMBER INDICATOR	BLUE INDICATOR	RED INDICATOR	MODE EXPLANATION	TROUBLESHOOTING ACTION
USER TROUBLESHOOTING	ON	OFF	OFF	THE MOBILE CHARGER HAS ENCOUNTERED A FAULT THAT REQUIRES TROUBLESHOOTING.	ENSURE THE ADAPTER AND CONTROL BOX ARE PROPERLY CONNECTED. DISCONNECT, THEN RECONNECT THE ADAPTER. IF THE MOBILE CHARGER IS WARM OR IN A HOT ENVIRONMENT, TRY CHARGING IN A COOLER AREA. TRY A DIFFERENT WALL SOCKET. TRY A DIFFERENT ADAPTER IF YOU HAVE ONE AVAILABLE. IF THE ERROR PERSISTS, CONTACT CONTRACTUAL PARTNER FOR SUPPORT.
NONRECOVERABLE FAULT	OFF	OFF	ON	THERE IS AN INTERNAL FAULT IN THE MOBILE CHARGER THAT CANNOT BE RECOVERED	TRY A DIFFERENT ADAPTER IF YOU HAVE ONE AVAILABLE. IF ERROR PERSISTS, CONTACT CONTRACTUAL PARTNER FOR SUPPORT.
NONRECOVERABLE FAULT (ADAPTER)	OFF	OFF	1 FLASH	THERE IS AN INTERNAL FAULT IN THE ADAPTER THAT CANNOT BE RECOVERED.	TRY USING ANOTHER ADAPTER IF YOU HAVE ONE AVAILABLE. IF NOT, CONTACT CONTRACTUAL PARTNER ABOUT OBTAINING A REPLACEMENT. IF YOUR WARRANTY HAS EXPIRED, YOU CAN ORDER A REPLACEMENT FROM YOUR WEBASTO DEALER.
GROUND LEAKAGE FAULT	OFF	OFF	PULSING	ELECTRICAL CURRENT IS LEAKING THROUGH A POTENTIALLY UNSAFE PATH.	POTENTIAL SHOCK HAZARD — IMMEDIATELY TURN OFF CIRCUIT BREAKER FOR THE WALL SOCKET WITHIN HOME. DISCONTINUE USE. CONTACT CONTRACTUAL PARTNER ABOUT OBTAINING A REPLACEMENT.

## 9 Disposal



The symbol of the crossed-out waste bin indicates that this electrical/electronic device must not be disposed of in household waste at the end of its service life. Dispose of the device free of charge at a local collection point for electrical/electronic devices. Addresses can be obtained from your city or local authority. Separate collection of electrical and electronic devices enables re-use, material recycling or other forms of re-utilization of waste equipment while also avoiding the negative effects of hazardous substances which may be contained in the devices on the environment and for human health.

- Dispose of packaging in corresponding recycling container in accordance with national regulations.

### Austria:

The EAG-VO ordinance in Austria incorporated EU law on waste electronic and electrical equipment into national legislation. This ordinance ensures that private households have the opportunity to return waste electronic and electrical equipment (WEEE) to public collection points free of charge. It is no longer permitted to dispose of WEEE in mixed municipal waste; instead, these must be handed in at the designated collection points. This allows functioning equipment to be reused, or valuable constituent parts of broken equipment to be recycled. The aim of this is to contribute to more efficient use of resources and more sustainable development. Moreover, it is only through separate collection that hazardous elements of the equipment (such as CFCs or mercury) can undergo sufficient treatment, thereby avoiding negative impacts on the environment and human health. There are municipal and manufacturer systems available for return and collection of your waste household equipment free of charge. An overview of available collection points can be found on the following website: <https://secure.umweltbundesamt.at/eras/registerabfrageEAGSammelstelleSearch.do>. All household electronic and electrical equipment is marked with the symbol of a crossed-out wheeled bin. This equipment may be handed in at any collection point listed under the above link, and should not be disposed of with household waste.

## 10 Declaration of conformity

The Webasto Go Mobile Charger was developed, manufactured, tested and supplied in accordance with the relevant directives, regulations and standards for safety, EMC and environmental compatibility.

Webasto Thermo & Comfort SE hereby declares that the "Webasto Go Mobile Charger" is in compliance with Directive 2014/35/EU.

The full text of the EU declaration of conformity can be found at the following web address:

<https://charging.webasto.com/int/products/documentation>

### 10.1 FCC information

This device complies with Part 15 of the FCC Rules. Operation is subject to the following conditions:

- This device may not cause harmful interference.
- This device must accept any interference received, including interference that may cause undesired operation.

This product has been designed to protect against Radio Frequency Interference (RFI). However, there are some instances where high-powered radio signals or nearby Radio Frequency (RF) producing equipment could affect operation.

If you suspect your charger is receiving interference, take the following steps before contacting Customer Support for service: <https://dealerlocator.webasto.com/en-int>

1. Relocate away from electrical appliances or equipment during charging.
2. Turn off nearby electrical appliances or equipment during charging.



#### NOTE

Changes or modifications to this product by anyone other than an authorized service provider will void FCC compliance and the product will not be serviceable.

To request this Installation Documentation in another language, please locate and contact your local Webasto dealer. You can find your nearest dealer at: <https://dealerlocator.webasto.com/en-int>.  
To provide feedback (in English or German) on this document, please email the Tech Doc and Translation team: [feedback2tdt@webasto.com](mailto:feedback2tdt@webasto.com)

USA:

Webasto Charging Systems, Inc.  
1333 S. Mayflower Ave.  
Monrovia, CA 91016  
USA

Tel: +1 (888) 833-2148  
[evscs@webasto.com](mailto:evscs@webasto.com)

UK only:

Webasto Thermo & Comfort UK Ltd  
Webasto House  
White Rose Way  
Doncaster Carr  
South Yorkshire  
DN4 5JH  
United Kingdom

Corporate headquarters:

Friedrichshafener Str. 9  
82205 Gilching  
Germany